

SGR15 Series

Specifications & Capacities			
Model Numbers	SGR1566	SGR1572	SGR1578
Weight	855 lbs.	904 lbs.	938 lbs.
Width	66 3/4"	72 3/4"	78 3/4"
Closed Height	30	30	30
Number of Teeth	21	23	25
Teeth Spacing	3"	3"	3"
Tooth Thickness	3/8"	3/8"	3/8"
Working Length of Teeth	37 3/4"	37 3/4"	37 3/4"
Hydraulic Cylinder	2" x 8" x 1 1/4" Rod	2" x 8" x 1 1/4" Rod	2" x 8" x 1 1/4" Rod
Maximum Pressure Rating	3500 psi		

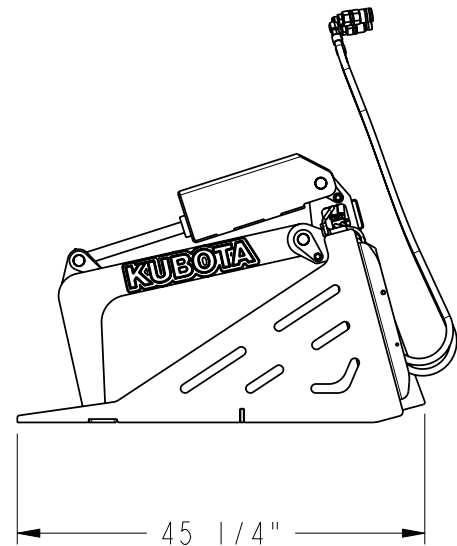
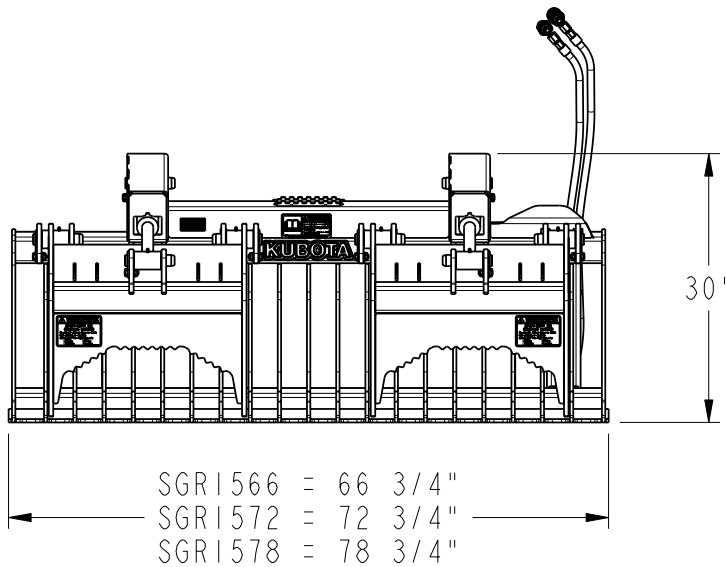

37866