

Electric Deck Lift Assembly Instructions



For Z48, Z54, ZSR54 & ZSR60 Zero Turn Mowers

Manual No. 357-372M

Before You Start



When you see this symbol, the subsequent instructions and warnings are serious - follow without exception. Your life and the lives of others depend on it!

IMPORTANT: Before you begin, read these instructions and check to be sure all parts and tools are accounted for. Please retain these installation instructions for future reference and parts ordering information.

Your Electric Deck Lift is exclusively designed for your Land Pride Z48, Z54, ZSR54 & ZSR60 model mowers. Please read these installation instructions and your mowers Operator's Manual thoroughly before beginning. Especially read information relating to safety concerns. Also included in the Operator's Manual is important information on operation, adjustment, troubleshooting, and maintenance for this attachment (some manual sections do not apply to all accessories).

A separate Parts Manual for your Zero Turn Mower is available free of charge at www.landpride.com or can be purchased from your nearest Land Pride dealer. Have the model and serial number of your mower handy when placing an order.

Manual Part Numbers:

Z48, Z54, ZSR54 & ZSR60

- Operator's Manual 357-344M
- Parts Manual (Z48 & Z54) 357-344P
- Parts Manual (ZSR54 & ZSR60) 357-344P

General Information

These assembly instructions apply to:

357-371A ELECTRIC DECK LIFT KIT, RAZOR

Tools required:

- Safety glasses
- Work gloves
- Phillips screwdriver
- Pliers
- 7/16" open end or box end wrenches

Further Assistance

Your dealer wants you to be satisfied with your new Electric Deck Lift. If for any reason you do not understand any part of this manual or are not satisfied with the service received, the following actions are suggested:

1. Discuss the matter with your dealership service manager making sure he is aware of any problems you may have and that he has had the opportunity to assist you.
2. If you are still not satisfied, seek out the owner or general manager of the dealership, explain the problem and request assistance.
3. For further assistance write to:

Land Pride Service Department
1525 East North Street
P.O. Box 5060
Salina, Ks. 67402-5060

E-mail address
lp servicedept@landpride.com

Assembly Instructions

A detailed listing of parts for this accessory kit is provided on page 7. Use the list as a checklist to inventory parts received. Please contact your local Land Pride dealer for any missing hardware.

Initial Preparations

1. Park unit on a flat surface.
2. Make sure blade engagement switch is **(OFF)**, control levers are fully **(OUT)** and park brake is **(ON)**.
3. Stop engine and remove switch key.
4. Raise seat deck fully up.

Refer to Figure 1:

5. Disconnect negative ground wire (black wire) from the battery's negative post (-). Place ground wire in a location where it cannot touch the battery posts.

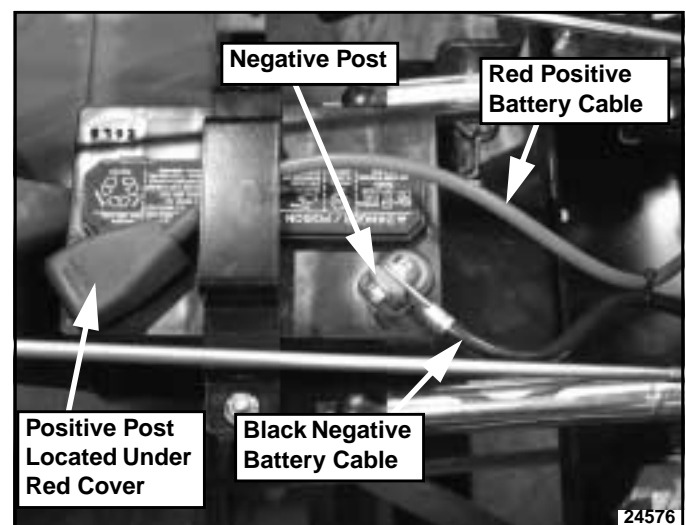

Remove Ground Wire From Battery
Figure 1

Toggle Switch Location

Refer to Figure 2:

Cut 15/32" diameter hole through console decal in the location shown to expose pre drilled hole under the decal.

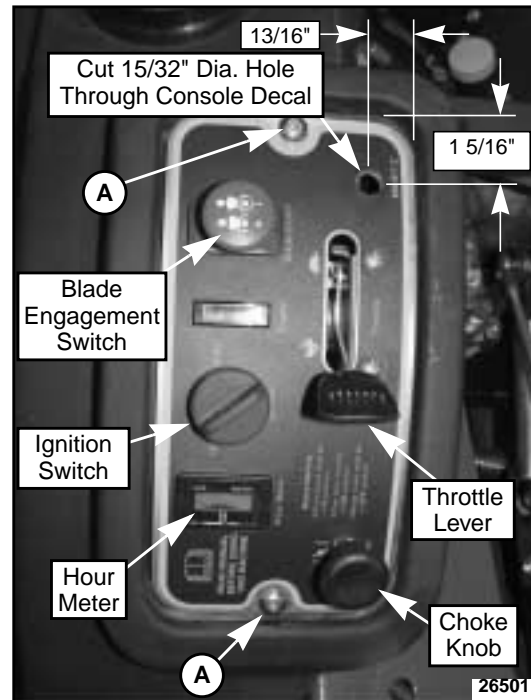

Console Panel Controls & Toggle Switch Location
Figure 2

Deck Lift Decal Installation

Refer to Figure 3:

1. Clean area around the hole with soap and water and then dry with a clean soft cloth.
2. Without removing the backing paper, position the deck lift decal (#11) over the hole with the down arrow pointing towards the front of the mower.
3. Hold decal in place while removing one-half of the backing paper and then press that side down.
4. Remove remaining backing paper and press the other decal half down. Smooth out decal to remove all air bubbles.

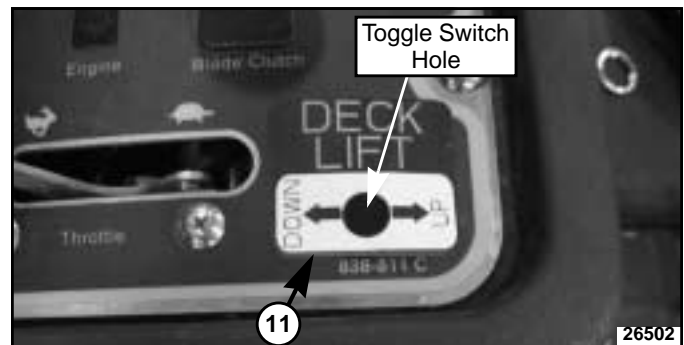

Proper Orientation of Deck Lift Decal
Figure 3

Remove Console Panel

Refer to Figure 4:

1. Raise seat up and locate on the right side the cable tie securing cables leading to the console panel.
2. Cut cable tie to free up cables so that the console panel can be lifted up to expose wiring below.

Refer to Figure 2:

3. Remove screws "A" and keep for reuse.
4. Lift console panel up to expose wiring below.

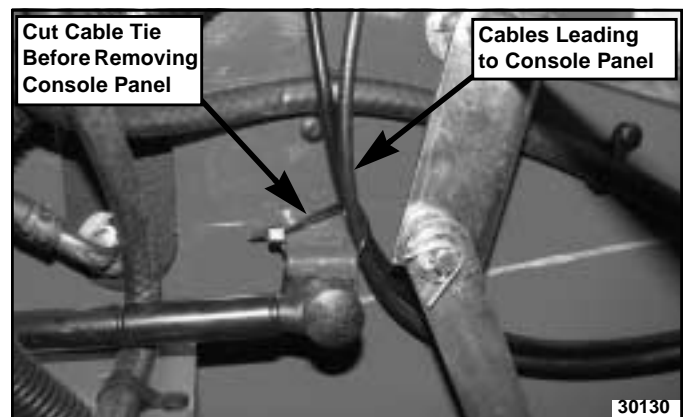

Remove Cable Tie Securing Console cables
Figure 4

Wire Harness Routing

Refer to Figure 6 & Figure 7:

1. Remove the two fuse covers "G1" and 30 amp fuses "G2" from fuse mounts "G3" on wiring harness (#10).

Refer to Figure 5 & Figure 7:

2. Route orange and yellow eyelets "E" & "F", 30 amp fuse mounts "G", actuator plug "H" and wiring harness (#10) through hole in bottom of console.
3. Pull wiring harness through hole until most of harness is outside of the console area. Keep terminals "A", "B", "C" & "D", toggle switch "J" and relay switch "K" inside the console cavity.
4. Replace 30 amp fuses and fuse covers.

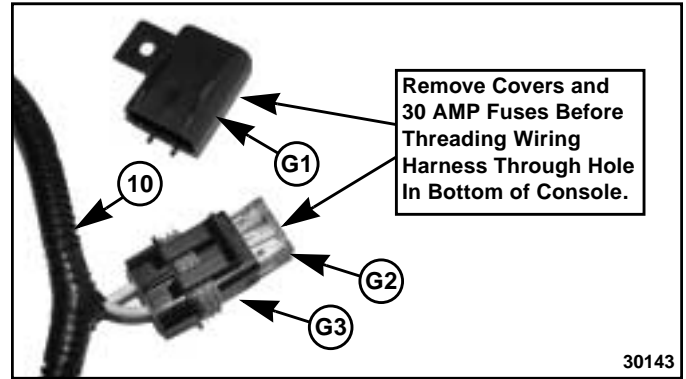

30 AMP Fuses "G"
Figure 6

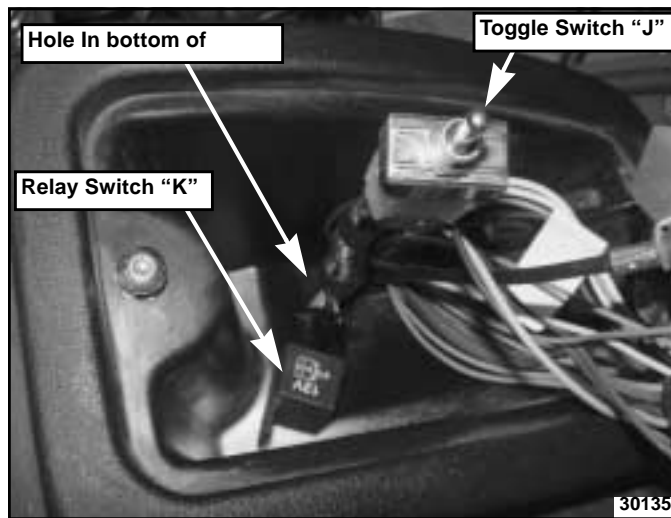

Insert Wire Harness Through Hole in Console Cavity
Figure 5

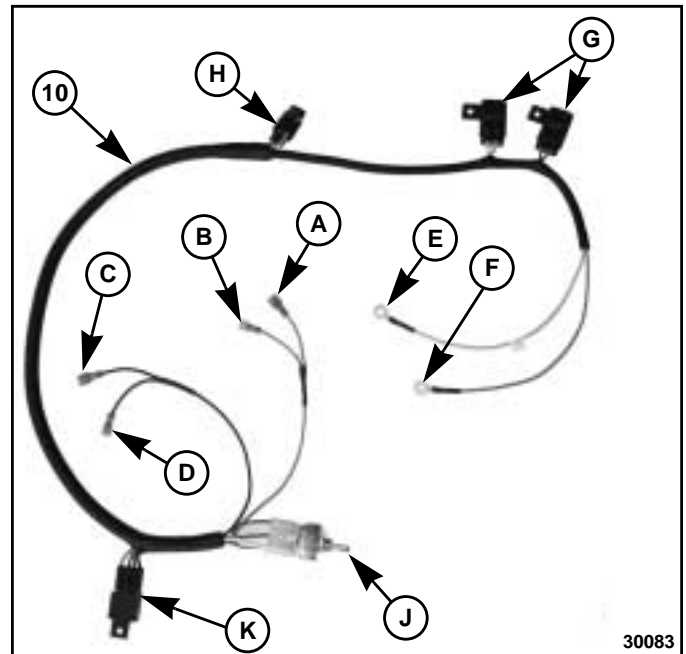

Wiring Harness (#10)
Figure 7

Wire Harness Terminal Connections

Refer to Figure 8:

1. Locate hour meter and its terminals on the backside of the console panel.
2. Notice that the gray wire is attached to the positive terminal (+) and black wire to the negative (-) terminal. Disconnect the two wires from the hour meter.

Refer to Figure 7 & Figure 8:

3. Attach deck lift wiring harness (#10) to the hour meter as follows:
 - Attach gray wire with female terminal "B" to the positive (+) terminal on the hour meter.
 - Attach black wire with female terminal "D" to the negative (-) terminal on the hour meter.
4. Attach deck lift wiring harness (#10) to wires pulled from the hour meter as follows:
 - Attach gray wire with male terminal "A" to the gray wire pulled from the hour meter.
 - Attach black wire with male terminal "C" to the black wire pulled from the hour meter.

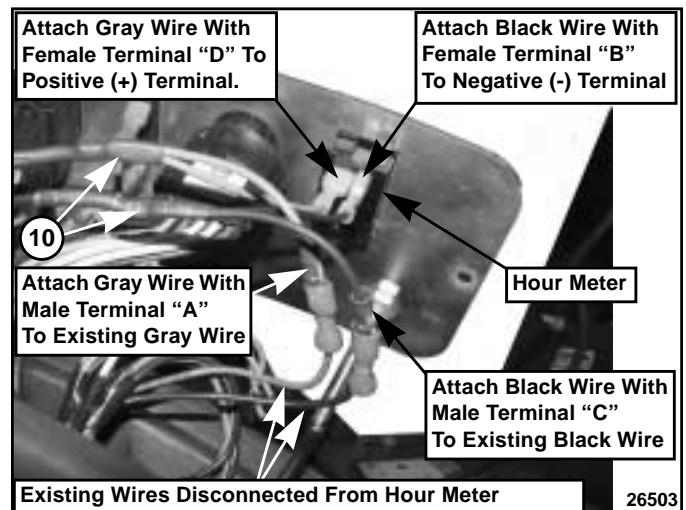

Wire Harness Terminal Connections
Figure 8

Toggle Switch Installation

Refer to Figure 9:

1. Remove knurled nut from toggle switch.
2. Turn hex jam nut on toggle switch all the way down.
3. Position toggle switch with keyed notch in threads facing towards the back (UP arrow side of decal).
4. Insert switch through 15/32" hole and secure with knurled nut. Hand tighten nut. Pliers may be used to tighten the knurled nut a little tighter.

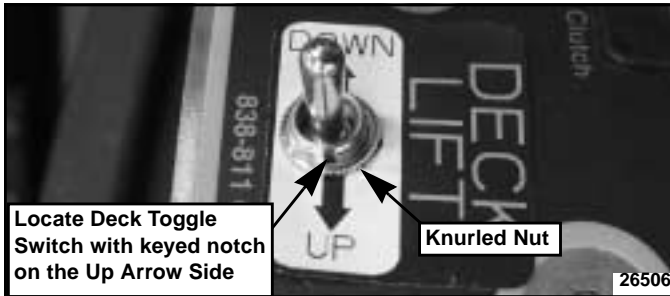

Toggle Switch Installation
Figure 9

Refer to Figure 10:

5. Replace console panel and tighten screws "A" at both ends of the panel.
6. Insert toggle switch boot (#12) over toggle switch lever and tighten nut.

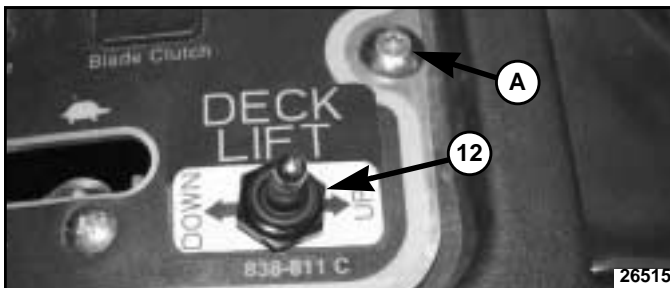

Toggle Switch Boot Installation
Figure 10

Refer to Figure 11:

7. Reattach existing console cables to mower side panel with cable tie (#1). Cut excess end of tie off.

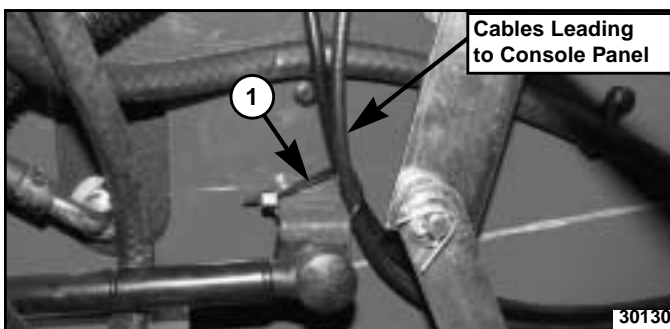

Secure Console Cables With New Cable Tie
Figure 11

Actuator Assembly

Refer to Figure 14:

1. Raise seat panel and locate lift arm pivot pin "P" on the right side.
2. Remove painted tape from lift arm pivot pin. Be sure all the tape and paint is removed from the pivot pin.

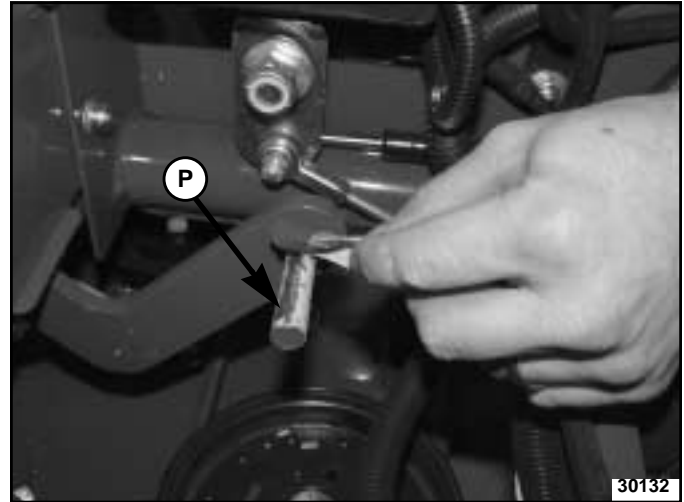

Remove Paint From Pivot Arm
Figure 12

Refer to Figure 13:

3. Remove the cable tie fastened to the hole in the engine upper fire wall so that carriage bolt (#4) can be installed. See Figure 14 on page 5 for illustration of carriage bolt (#4).

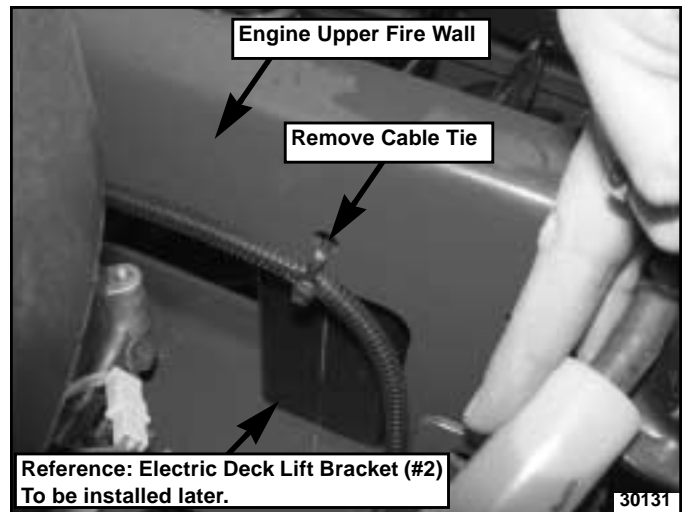

Remove Cable Tie Securing Engine Wire Harness
Figure 13

Assembly Instructions

Refer to Figure 14:

4. Attach electric deck lift bracket (#2) to engine firewall by inserting its notched bottom onto the lower firewall lip and then bolting the top to the upper firewall with the 3/8"-16 x 3/4" carriage bolt (#4) and hex flange nut (#5). Tighten nut to 31 ft-lbs.
5. Slide base end of actuator (#9) onto lift arm "P".
6. Slide 1/2" flat washer (#6A) onto lift arm "P" and insert 15/32" cotter pin (#7A). Bend one or more legs of the cotter pin to secure it in place.
7. Align rod end of actuator between the two long slots in lift bracket (#2).
8. Insert 1/2" x 3 1/2" clevis pin (#8) through 1/2" flat washer (#6B), slot in right side of lift bracket (#2), 1" spacer (#3A), actuator rod, 1" spacer (#3B), slot in left side of lift bracket (#2) and 1/2" flat washer (#6C).
9. Insert cotter pin (#7B) into clevis pin (#8). Bend one or more legs of the cotter pin to secure it in place.

Refer to Figure 15:

1. Attach wiring harness (#10) to actuator receptacle with actuator plug "H".

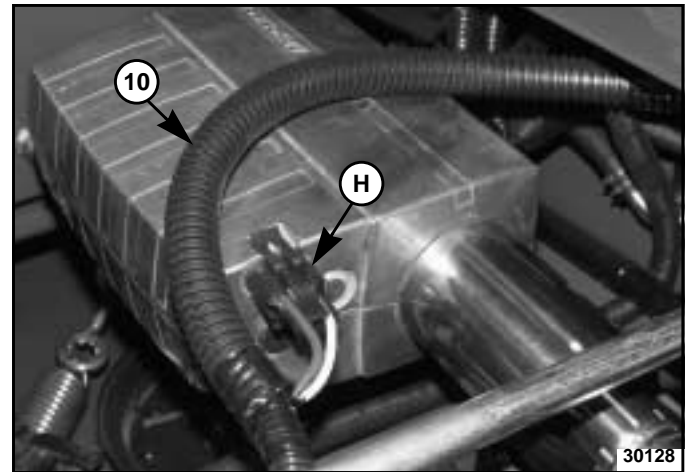

Connect Wire Harness to Actuator Receptacle
Figure 15

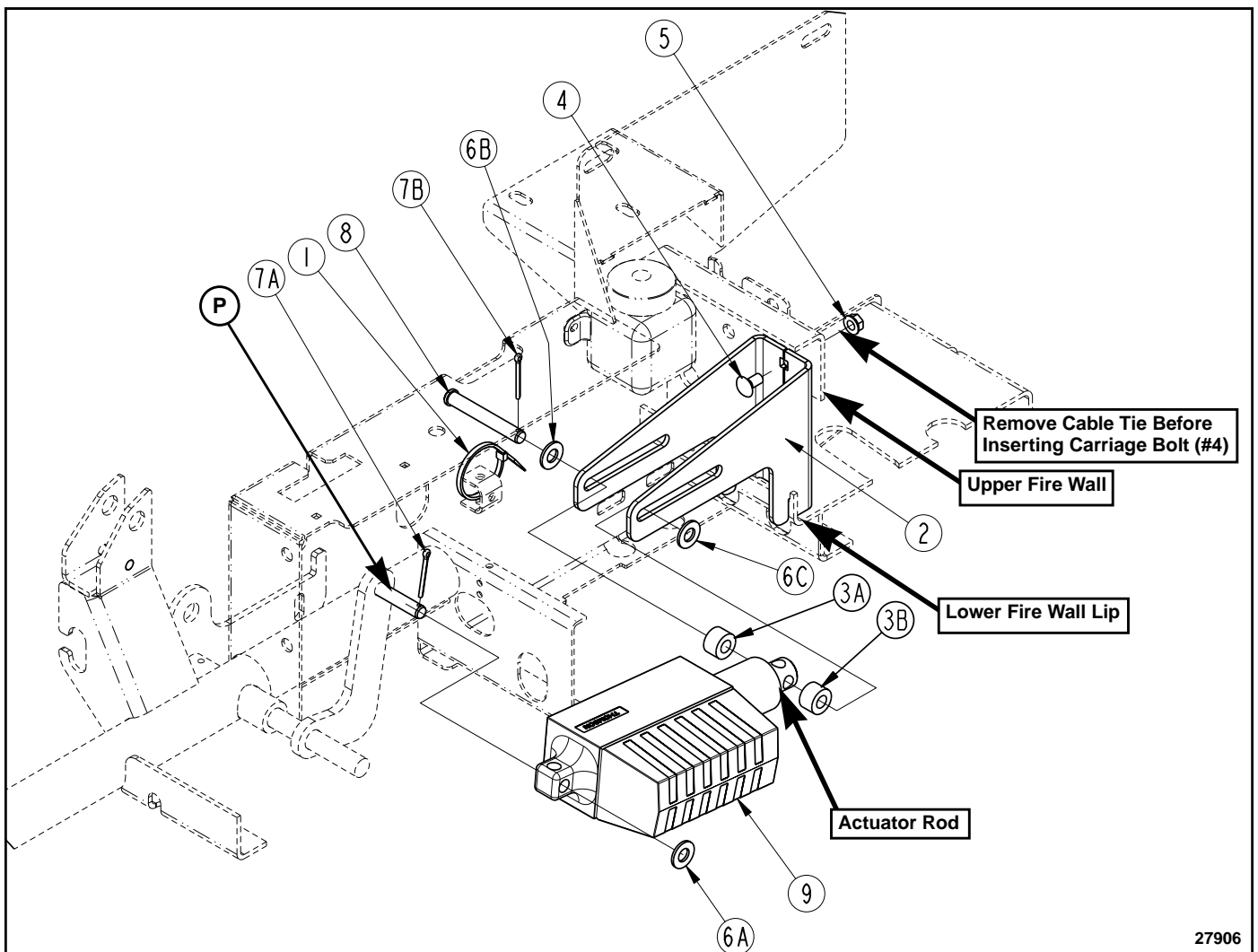

Actuator Assembly
Figure 14

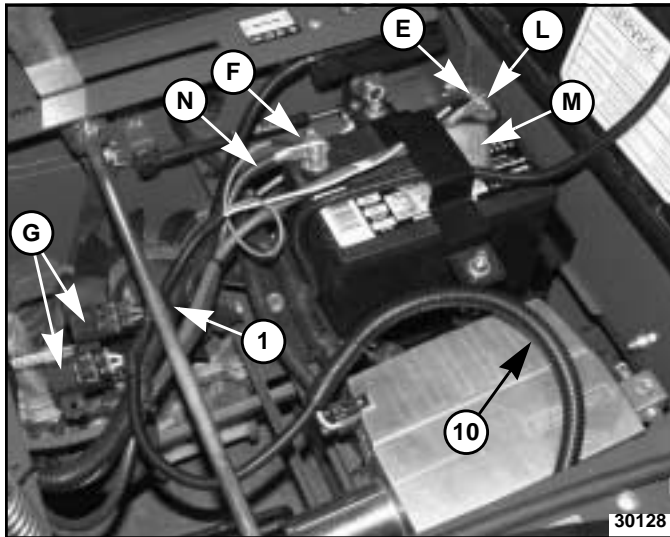

Battery Hook-up
Figure 16

Battery Hook-Up

Refer to Figure 16:

1. Connect yellow eyelet "E" and red battery cable "L" to the battery's positive (+) post. Tighten fasteners at the battery post and cover post with red cover "M".
2. Connect orange eyelet "F" and black battery cable "N" to the battery's negative (-) post. Tighten fasteners at the battery post.
3. Tie 30 AMP fuses "G" to existing mower wiring harness with cable tie (#1). Cut excess end of tie off.

Actuator Test Run

Test actuator for proper operation as follows:

Refer to Figure 13:

1. Turn switch key to run position. Raise mower deck fully up by moving toggle switch (#12) back towards "Arrow Up" position.
2. When fully up, stop handle "A" should drop into transport notch "B".

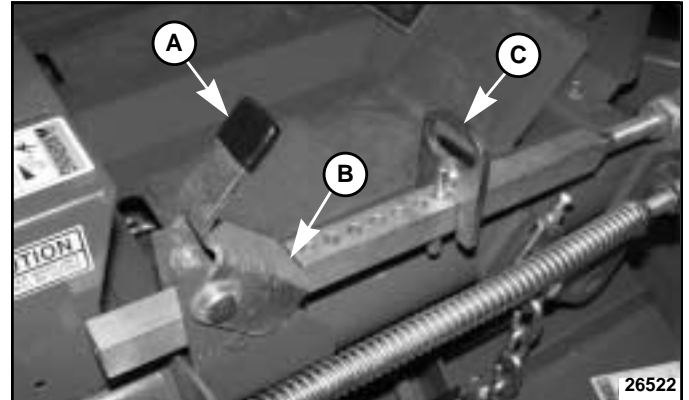

Actuator Mount Installation (Rear Bolt)
Figure 17

Operating Instructions

Refer to Figure 17:

IMPORTANT: Use actuator only for lifting and lowering the deck. Never carry deck weight with the actuator. Always carry deck weight with stop handle "A" against deck height adjusting stop "C" or against transport notch "B".

1. Raise deck up until stop handle "A" falls into the transport notch "B" and then lower deck until stop handle comes against the transport notch.
2. Place deck height adjusting stop "C" in a cutting height gauge hole.
3. Raise deck up only enough to lift stop handle out of the transport notch and then lower deck until the stop handle comes against the deck height adjusting stop.

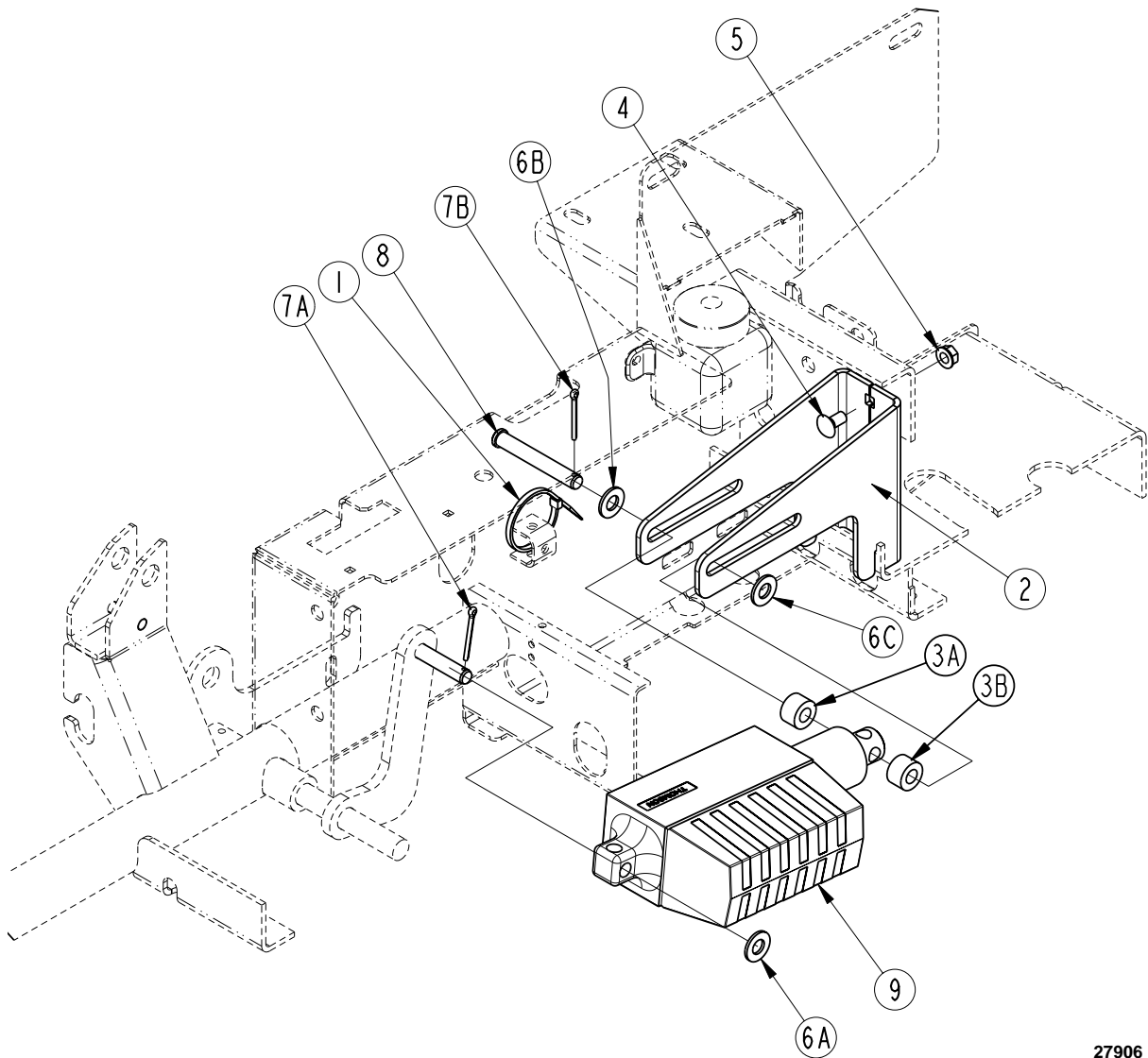

27906

Electric Deck Lift Kit (Items 10, 11 & 12 Not Shown)
Figure 18

Kit No. 357-371

ELECTRIC DECK LIFT KIT, RAZOR

Item	Part No.	Part Description	Qty
1	800-112C	CABLE TIE .19 X 7.25 1.75D	2
2	357-370H	ELEC DECK LIFT BRACKET.....	1
3	357-859D	SPACER, 1ODX1/4WL.....	2
4	802-149C	RHSNB 3/8-16X3/4 GR5.....	1
5	803-068C	NUT HEX FLANGE 3/8-16 PLT.....	1
6	804-016C	WASHER FLAT 1/2 SAE PLT.....	3
7	805-089C	PIN COTTER 5/32 X 1 1/2 LONG.....	2
8	805-108C	PIN CLEVIS 1/2 X 3 1/2 PLT.....	1
9	833-466C	ELECT. LINEAR ACTUATOR 4IN STK.....	1
10	833-490C	HARNESS, ELECTRIC DECK LIFT - (See Figure 7 on page 3).....	1
11	848-290C	DECAL, DECK LIFT, UP DOWN - (See Figure 3 on page 2).....	1
12	833-499C	BOOT, TOGGLE SWITCH - (See Figure 10 on page 4).....	1
13	357-372M	MANUAL, ELECTRIC DECK LIFT KIT, RAZOR.....	1



Corporate Office: P.O. Box 5060
Salina, Kansas 67402-5060 USA
www.landpride.com
